

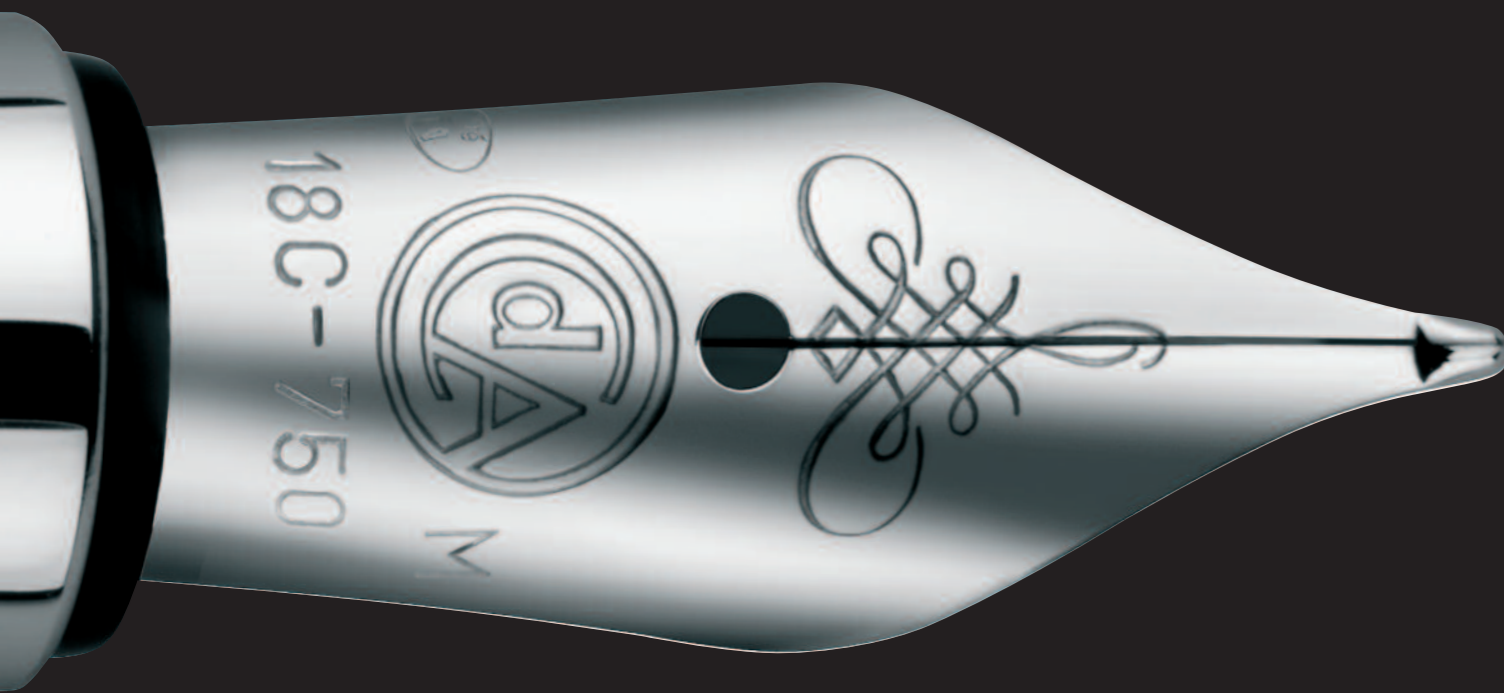

WRITING INSTRUMENTS
THE COLLECTION



MAISON DE HAUTE ECRITURE

With its priceless legacy of expertise,
Caran d'Ache is keeping the art of writing
alive and well.

In the great Swiss manufacturing tradition, it works with
passion and rigor to create exceptional products.

Caran d'Ache writing instruments are recognised the world over for
their excellence and their daring combination of technology and aesthetics.

They are technical marvels that have a strong emotional appeal. By
combining originality in the use of materials with perfection of form
they make writing by hand a genuinely refined experience.

When you offer a Caran d'Ache luxury writing, drawing
instrument or accessory, you are choosing a
symbol of prestige and style that affirms your
love of beautiful things.



THE CARAN D'ACHE FOUNTAIN PEN: THE IDEAL INSTRUMENT FOR HANDWRITING

"The pen is the interpreter of the soul: what one thinks, the other expresses."
(Miguel de Cervantes)

Each Caran d'Ache writing instrument combines high technology with the
matchless expertise of the craftsman. The nib and the ink feed both receive
special attention and their secrets are carefully guarded.

From the machining of the ink-feed channel to the curvature and polishing of the
pen, Swiss precision gives these writing instruments the genuine stamp of
quality.

To offer personalized writing style and comfort, the nib of a fountain pen in the
Varius collection is available in six point sizes, and in three sizes in the other
collections.

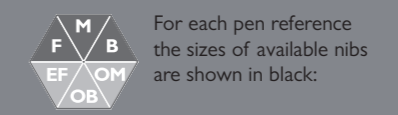
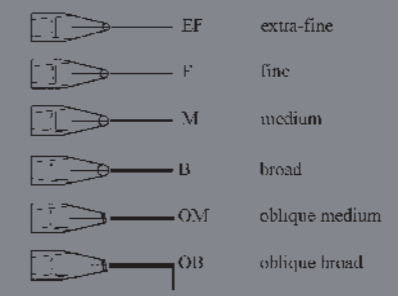

The fountain pens are supplied with a piston pump and two blue Caran d'Ache
cartridges: the roller balls with a fine black cartridge, the ballpoint pens with a
black Goliath giant cartridge, and the mechanical pencils with leads of 0.7mm
diameter (except Ecridor XS: 0.5mm and Ecridor Artiste: 2mm).

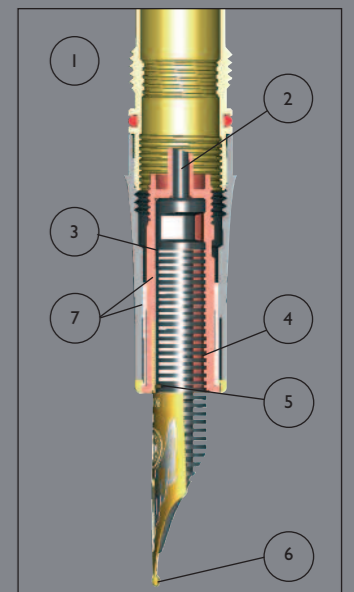

1. Front parts of a fountain pen
 2. Inkfeeder, an essential component for the ink flow
 3. Capillary ink-feed canal
 4. Ribs to compensate for changes in temperature and altitude
 5. Air-ink exchanger system
 6. Pen with welded and polished iridium ball
 7. The house and the body of the nib
- All parts of a Caran d'Ache writing block are assembled manually.

Each Caran d'Ache pen block must pass leakage, writing, and fast-writing tests. The nibs are then adjusted and ground by hand.



“SWISS MADE” SINCE 1924

Caran d’Ache, founded in 1924 by Arnold Schweitzer, was a product of Switzerland’s long history of watchmaking and jewellery manufacture. Today, it is the epitome of superior quality and recognized expertise.

The company is the country’s only manufacturer of pencils, fine-arts materials and luxury writing instruments. It is a symbol of Swiss technical excellence, precision, reliability and innovation.

Each product is created by hand in the Geneva workshops and brings together the traditional expertise of master craftsmen and the performance of computer-assisted machine tools.

Each Caran d’Ache pen carries the “Swiss Made” label. With its famous Goliath ballpoint cartridge it ensures perfect writing quality with a capacity of up to 600 A4 pages. A crucial part of its tradition of seeking perfection is its expertise in controlling the components of fountain pen blocks and the ink-feed system, whose secret is jealously guarded.

Writing instruments are tested individually and ensure a level of comfort in handwriting which only a Maison de Haute Ecriture can provide.

Lifetime guarantee* and after-sales service ensure the best for these exceptional instruments.

Lovers of handwriting often develop a real attachment to their pens. For this reason, our after-sales technicians do their very best to repair them whenever possible, only replacing them as a last resort. Repairs under guarantee are free of charge and other repairs are only carried out after the client has accepted a cost estimate.

Caran d’Ache writing instruments are created by hand, inspected and tested at each stage of production. When they leave the Geneva workshops they are in perfect condition and are guaranteed against any manufacturing defects. This international guarantee certificate accompanies each pen.

**For the majority of writing instruments in Caran d’Ache collections. Certain special editions are excluded.*

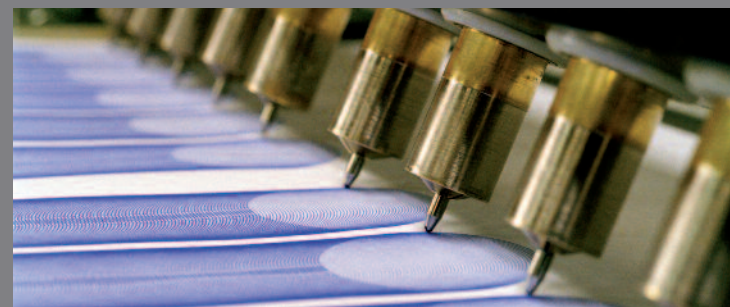
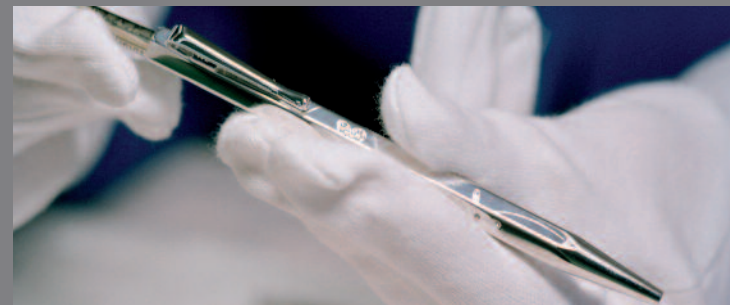

SUMMARY

JEWELLERY COLLECTION Page 6

HEXAGONAL COLLECTION Page 10

CARAN D’ACHE MATERIALS Page 12

VARIUS COLLECTION Page 14

LÉMAN COLLECTION Page 20

MADISON COLLECTION Page 26

ECRIDOR COLLECTION Page 30

INKS Page 40

REFILLS Page 41



IVANHOE, SOLID YELLOW GOLD



Fountain pen, 6 diamonds
18 ct. gold nib
5044.101
Fountain pen, 18 ct. gold nib
5044.103



Ballpoint pen
6 diamonds
5044.102
Ballpoint pen
5044.104

PERSONALISATION



Settings of precious stones, diamonds, rubies, sapphires, emeralds and engraved with a name, initials or even a short message... Caran d'Ache offers all lovers of rare art objects the possibility of personalising their writing instrument. They can order a personal design by choosing the noble metal and the colour, as well as the number of precious stones that will then be set by a Geneva jeweller. Each personalised, unique writing instrument is numbered, engraved and delivered with its certificate.

 LÉMAN, SOLID YELLOW GOLD



Fountain pen,
34 diamonds
18 ct. gold nib
5089.100

Fountain pen,
20 diamonds
(ring),
18 ct. gold nib
5089.107

Fountain pen,
14 diamonds
(button),
18 ct. gold nib
5089.101

Roller pen,
34 diamonds
5089.200

Roller pen,
20 diamonds
(ring)
5089.209



Ballpoint pen,
29 diamonds
5089.383

Ballpoint pen,
17 diamonds
(ring)
5089.382



 LÉMAN, SOLID ROSE GOLD



Fountain pen,
34 diamonds
18 ct. gold nib
5089.110

Fountain pen,
20 diamonds
(ring),
18 ct. gold nib
5089.109

Fountain pen,
14 diamonds
(button),
18 ct. gold nib
5089.108

Roller pen,
34 diamonds
5089.250

Roller pen,
20 diamonds
(ring)
5089.259



Ballpoint pen,
29 diamonds
5089.483

Ballpoint pen,
17 diamonds
(ring)
5089.482



 MADISON, SOLID YELLOW GOLD



Fountain pen,
10 diamonds
(button),
18 ct. gold nib
5046.101

Fountain pen,
18 ct. gold nib
5046.100

Rollerball pen,
10 diamonds
(button)
5046.201

Rollerball pen
5046.200

Ballpoint pen,
9 diamonds
(button)
5046.301

Ballpoint pen
5046.300



 MADISON, SOLID ROSE GOLD



Fountain pen,
10 diamonds
(button),
18 ct. gold nib
5046.151

Fountain pen,
18 ct. gold nib
5046.150

Rollerball pen,
10 diamonds
(button)
5046.251

Rollerball pen
5046.250

Ballpoint pen,
9 diamonds
(button)
5046.351

Ballpoint pen
5046.350



CHINESE LACQUER "ÉCAILLE"
 GOLD-PLATED TRIMS



Fountain pen,
 18 ct. gold nib
 5882.485



Rollerball pen
 5872.485



Ballpoint pen
 5892.485



Mechanical pencil,
 Ø 0,7mm
 5862.485



CUBES
 SILVER-PLATED, RHODIUM-COATED



Fountain pen,
 18 ct. gold nib
 rhodium-coated
 5880.406



Rollerball pen
 5870.406



Ballpoint pen
 5890.406



Mechanical pencil,
 Ø 0,7mm
 5860.406

HAND MADE FOR HANDWRITING

Caran d'Ache writing instruments demonstrate recognized expertise in working with different materials. Created by a large number of delicate operations and submitted to rigorous checking, they offer a level of refinement in the smallest details which is the mark of exceptional writing instruments. Using noble materials such as gold, silver, rhodium, platinum, Chinese lacquer and wood, or high-technology materials such as carbon fibre, Caran d'Ache's exclusive craftsmanship produces instruments that are very attractive both to the eye and the hand.

18-CARAT YELLOW GOLD / ROSE GOLD

Gold, the noblest of metals, brings an incomparable softness to a pen, and has inspired Caran d'Ache to design its most beautiful objects, in classical and contemporary styles. In the pure tradition of Swiss goldsmiths, craftsmen cut, decorate, engrave and polish the gold to dress each writing instrument and in so doing create real works of art. The gold they use is certified by the Office of Precious Metals and carries its hallmark, as well as the personal mark of the craftsman.

SILVER

Writing instruments in solid silver are controlled by the Federal Office of Precious Metals and carry its hallmark, as well as the personal mark of the craftsman. The silver used in silver-plated elements is 999/1000 fine.

PLATINUM

Platinum is a noble and precious grey-white metal used to protect some Caran d'Ache writing instruments, thus allowing them to keep their shine over the years. Its purity gives them a white lustre which enhances the magnificent diamonds. Rare, pure, unalterable, platinum is the most exclusive precious metal. Its rarity makes it a treasure much coveted by connoisseurs. Extremely resistant to corrosion, oxidation, abrasion and shine loss, it is perfectly suitable for jewellery and frequently used in this field.

RHODIUM

Rhodium is a rare metal in the platinum family and is about 10 times more expensive than gold. It is extremely hard but its principal advantage is that, because it does not oxidise, it always keeps its magnificent silver sheen. Rhodium is often used with silver to preserve its beautiful appearance.



18-carat
yellow gold / rose gold

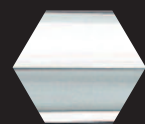

Silver

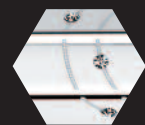

Platinum

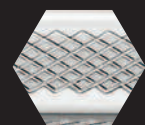

Rhodium



Chinese lacquer



Lacquer

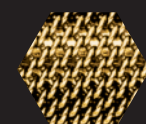

Coat of mail

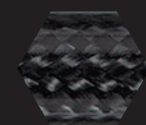

Carbon fibre



Rosewood

CHINESE LACQUER

Caran d'Ache is proud to be one of the very few Western manufacturers of writing instruments to use this wonderful material. Blue, black or red Chinese lacquer gives a magnificent finish to lighters and writing instruments in the Hexagonal and Varius collections as well as some limited editions. Chinese lacquer is a natural product derived from the sap of the "Tsi-Chéou" tree. The highly complex art of preparing and applying it in the manner of the great Eastern masters has inspired the craftsmen of Caran d'Ache.

LACQUER

Lacquer is a precious, refined material that requires great care and attention in its application as well as its finishing. Polished repeatedly, it develops all its wonderful shine in the hands of a craftsman.

COAT OF MAIL

In its innovative use of coat of mail, Caran d'Ache has made the most of this legendary material that once protected medieval knights. Its woven links of stainless steel create a very pleasant texture in the writer's hand. Coat of mail even comes in a gold-plated version.

CARBON FIBRE

Carbon fibre is the epitome of a modern material. Its lightness and outstanding rigidity give it an immediate appeal and Caran d'Ache uses it to create a new, high-tech interpretation of tradition. Removed from its normal environment of top-level sports, and linked with silver-plated elements, carbon fibre brings power and strength to the Varius line.

ROSEWOOD

This wood comes from a tree in Brazil, the thinness of its veins, its hardness and its resistance make it a greatly prized wood among cabinetmakers.

HIGH STANDARDS AND RIGOUR IN THE CHOICE AND USE OF PRECIOUS MATERIALS

The gold, silver, platinum and rhodium used in our writing instruments all conform to the regulations concerning the use of precious metals. Manufacturing tolerances are strictly respected and each pen is individually inspected before being released for sale. Caran d'Ache works only with suppliers who meet strict conditions. All materials are carefully verified or analysed when they are received. Precious metals, gold, silver, platinum and rhodium are all conform to the regulations in force under Swiss law on working with precious metals.



IVANHOE, COAT OF MAIL
GOLD-PLATED TRIMS



Fountain pen,
18 ct. gold nib
4490.514

Rollerball pen
4470.514

Ballpoint pen
4480.514

Mechanical pencil,
Ø 0,7mm
4460.514



IVANHOE, COAT OF MAIL
SILVER-PLATED, RHODIUM-COATED TRIMS

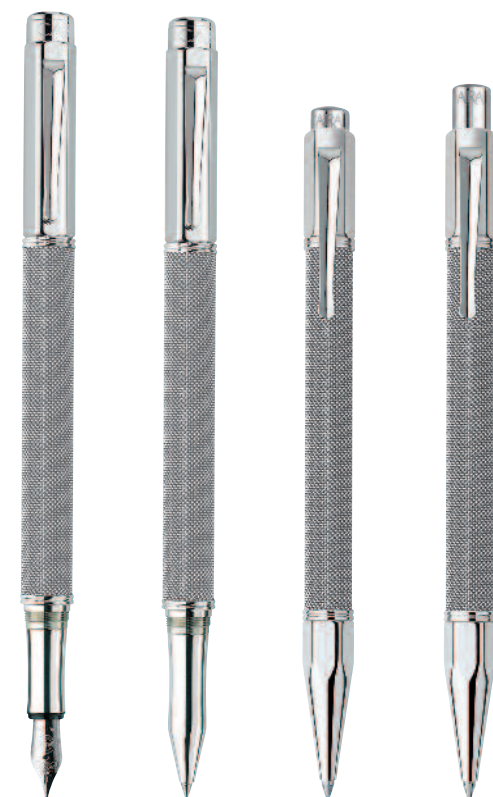

Fountain pen,
18 ct. gold nib
rhodium-coated
4490.014

Rollerball pen
4470.014

Ballpoint pen
4480.014

Mechanical pencil,
Ø 0,7mm
4460.014



CHINABLACK, CHINESE LACQUER BLACK
GOLD-PLATED TRIMS



Fountain pen,
18 ct. gold nib
4490.018



Rollerball pen
4470.018



Ballpoint pen
4480.018



Mechanical pencil,
Ø 0,7mm
4460.018



CHINABLACK, CHINESE LACQUER BLACK
SILVER-PLATED, RHODIUM-COATED TRIMS



Fountain pen,
18 ct. gold nib
rhodium-coated
4490.020

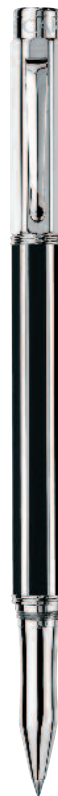

Rollerball
4470.020



Ballpoint pen
4480.020



Mechanical pencil,
Ø 0,7mm
4460.020



CHINABLUE, CHINESE LACQUER BLUE
SILVER-PLATED, RHODIUM-COATED TRIMS



Fountain pen,
18 ct. gold nib
rhodium-coated
4490.019



Rollerball pen
4470.019



Ballpoint pen
4480.019



Mechanical pencil,
Ø 0,7mm
4460.019





CARBON 3000, CARBON FIBRE
SILVER-PLATED, RHODIUM-COATED TRIMS



Fountain pen,
18 ct. gold nib
rhodium-coated
4490.017



Rollerball pen
4470.017



Ballpoint pen
4480.017



Mechanical pencil,
Ø 0,7mm
4460.017



METWOOD, ROSEWOOD
SILVER-PLATED, RHODIUM-COATED TRIMS



Fountain pen,
18 ct. gold nib
rhodium-coated
4490.015



Rollerball pen
4470.015



Ballpoint pen
4480.015



Mechanical pencil,
Ø 0,7mm
4460.015



METRUB, GENUINE RESIN
SILVER-PLATED, RHODIUM-COATED TRIMS



Fountain pen,
18 ct. gold nib
rhodium-coated
4490.016



Rollerball pen
4470.016



Ballpoint pen
4480.016



Mechanical pencil,
Ø 0,7mm
4460.016



EBONY BLACK
GOLD-PLATED TRIMS



Fountain pen,
18 ct. gold nib
bicolor
4799.282

Rollerball pen
4779.282



Ballpoint pen
4789.282



Mechanical pencil,
Ø 0,7mm
4769.282

EBONY BLACK
SILVER-PLATED, RHODIUM-COATED TRIMS



Fountain pen,
18 ct. gold nib
rhodium-coated
4799.782

Rollerball pen
4779.782



Ballpoint pen
4789.782



Mechanical pencil,
Ø 0,7mm
4769.782



BICOLOR BLACK
SILVER-PLATED, RHODIUM-COATED TRIMS



Fountain pen,
18 ct. gold nib
rhodium-coated
4799.289



Rollerball pen
4779.289



Ballpoint pen
4789.289



Mechanical pencil,
Ø 0,7mm
4769.289



MIRROR
SILVER-PLATED, RHODIUM-COATED TRIMS



Fountain pen,
18 ct. gold nib
rhodium-coated
4799.214



Rollerball pen
4779.214



Ballpoint pen
4789.214



Mechanical pencil,
Ø 0,7mm
4769.214

BICOLOR BLUE NIGHT
SILVER-PLATED, RHODIUM-COATED TRIMS



 Fountain pen, 18 ct. gold nib rhodium-coated 4799.549
 Rollerball 4779.549
 Ballpoint pen 4789.549
 Mechanical pencil, Ø 0,7mm 4769.549

BICOLOR SAFFRON
SILVER-PLATED, RHODIUM-COATED TRIMS



 Fountain pen, 18 ct. gold nib rhodium-coated 4799.530
 Rollerball pen 4779.530
 Ballpoint pen 4789.530
 Mechanical pencil, Ø 0,7mm 4769.530

BICOLOR RED
SILVER-PLATED, RHODIUM-COATED TRIMS



 Fountain pen, 18 ct. gold nib rhodium-coated 4799.184
 Rollerball 4779.184
 Ballpoint pen 4789.184
 Mechanical pencil, Ø 0,7mm 4769.184

BICOLOR ROSE
SILVER-PLATED, RHODIUM-COATED TRIMS



 Fountain pen, 18 ct. gold nib rhodium-coated 4799.080
 Rollerball 4779.080
 Ballpoint pen 4789.080
 Mechanical pencil, Ø 0,7mm 4769.080





CISELÉ
GOLD-PLATED



Fountain pen,
18 ct. gold nib
4690.282

Rollerball pen
4670.282

Ballpoint pen
4680.282

Mechanical pencil,
Ø 0,7mm
4660.282



CISELÉ
SILVER-PLATED, RHODIUM-COATED



Fountain pen,
18 ct. gold nib
rhodium-coated
4690.286

Rollerball pen
4670.286

Ballpoint pen
4680.286

Mechanical pencil,
Ø 0,7mm
4660.286



Clou de Paris
SILVER-PLATED, RHODIUM-COATED



Fountain pen,
18 ct. gold nib
rhodium-coated
4690.386

Rollerball pen
4670.386

Ballpoint pen
4680.386

Mechanical pencil,
Ø 0,7mm
4660.386



BICOLOR BLACK
SILVER-PLATED, RHODIUM-COATED TRIMS



Fountain pen,
18 ct. gold nib
rhodium-coated
4690.456

Rollerball pen
4670.456

Ballpoint pen
4680.456

Mechanical pencil,
Ø 0,7mm
4660.456



BICOLOR BLUE
SILVER-PLATED, RHODIUM-COATED TRIMS



Fountain pen,
18 ct. gold nib
rhodium-coated
4690.486

Rollerball pen
4670.486

Ballpoint pen
4680.486

Mechanical pencil,
Ø 0,7mm
4660.486



BICOLOR RED
SILVER-PLATED, RHODIUM-COATED TRIMS



Fountain pen,
18 ct. gold nib
rhodium-coated
4690.470

Rollerball pen
4670.470

Ballpoint pen
4680.470

Mechanical pencil,
Ø 0,7mm
4660.470

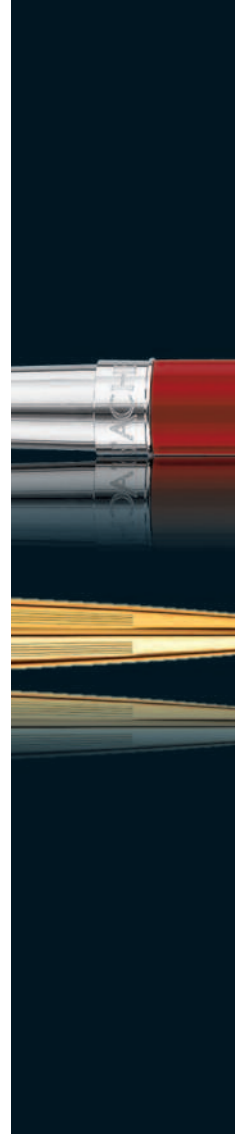

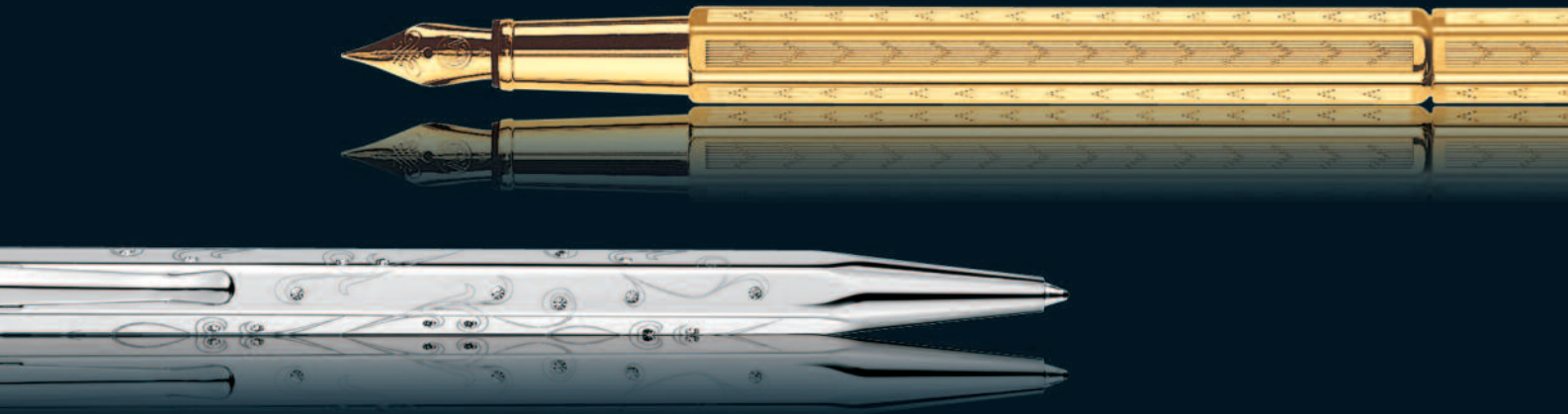

CHEVRON
GILDED



RETRO
GILDED



Fountain pen,
steel nib gilded
958.208



Rollerball pen
838.208



Ballpoint pen
898.208



Mechanical pencil,
Ø 0,7mm
4.208



Fountain pen,
steel nib gilded
958.488



Rollerball pen
838.488



Ballpoint pen
898.488



Mechanical pencil,
Ø 0,7mm
4.488



MAYA
GILDED



Fountain pen,
steel nib gilded
958.348

Rollerball pen
838.348

Ballpoint pen
898.348

Mechanical pencil,
Ø 0,7mm
4.348



CHEVRON
SILVER-PLATED, RHODIUM-COATED



Fountain pen,
steel nib
rhodium-coated
958.286

Rollerball pen
838.286

Ballpoint pen
890.286

Mechanical pencil,
Ø 0,7mm
4.286



Mechanical pencil,
Chevron
Artiste
Ø 2mm in
a wooden box
42.786
Blue lead
Green lead
Red lead
Yellow lead



RETRO
SILVER-PLATED, RHODIUM-COATED



Fountain pen,
steel nib
rhodium-coated
958.485

Rollerball pen
838.485

Ballpoint pen
890.487

Mechanical pencil,
Ø 0,7mm
4.486



MAYA
SILVER-PLATED, RHODIUM-COATED



Fountain pen,
steel nib
rhodium-coated
958.346

Rollerball pen
838.346

Ballpoint pen
890.346

Mechanical pencil,
Ø 0,7mm
4.346



 ECRIDOR *Nuit d'Hiver*
SILVER-PLATED, PLATINUM-COATED
WITH CRYSTALLYZED™ - Swarovski Elements

Ecridor Eclat "Nuit d'Hiver":
the glittering sky
on a winter's night captured
by Swarovski crystals

Caran d'Ache,
Maison de Haute Ecriture,
reinvents winter every year.
In its Geneva workshops
the company creates
an exceptional pen
in limited numbers.

Ever since the launch in 2005,
the Ecridor Eclat has become
one of the brand's
"must have" products
and the new Ecridor Eclat
Nuit d'Hiver will brighten up
the winter months
in 2007 /2008.



Ballpoint pen
890.986



 ECRIDOR ECLAT
SILVER-PLATED, RHODIUM-COATED
WITH CRYSTALLYZED™ - Swarovski Elements

 GRAIN D'ORGE
STERLING SILVER 925
RHODIUM-COATED



Ballpoint pen
890.786



Ballpoint pen
891.287



Mechanical pencil,
Ø 0,7mm
4.287



ECRIDOR TYPE 55
SILVER-PLATED, RHODIUM-COATED



Fountain pen,
18 ct. gold nib,
rhodium-coated
959.455



Rollerball
838.455



Ballpoint pen
890.455



Mechanical pencil,
Ø 0,7mm
4.455



Mechanical
pencil,
Type 55 Artiste,
Ø 2mm
42.455
Blue lead
Green lead
Red lead
Yellow lead



ECRIDOR XS RETRO
SILVER-PLATED, RHODIUM-COATED



Fountain pen,
steel nib
rhodium-coated
996.486



Ballpoint pen
896.486



Mechanical pencil,
Ø 0,5mm
404.486



ECRIDOR XS CHEVRON
SILVER-PLATED, RHODIUM-COATED



Fountain pen,
steel nib
rhodium-coated
996.286



Ballpoint pen
896.286



Mechanical pencil,
Ø 0,5mm
404.286



ECRIDOR XS MAYA
SILVER-PLATED, RHODIUM-COATED



Fountain pen,
steel nib
rhodium-coated
996.346



Ballpoint pen
896.346



Mechanical pencil,
Ø 0,5mm
404.346



ECRIDOR XS AMMONITE RUBY
STERLING SILVER 925
RHODIUM-COATED



Ballpoint pen
896.187



Mechanical pencil,
Ø 0,5mm
404.187



ECRIDOR XS COUTURE
ROSE GOLD-PLATED
WITH CRYSTALLIZED® - Swarovski Elements



Fountain pen,
rose gold nib
996.586



Roller pen
866.586



Ballpoint pen
896.586



Mechanical pencil,
Ø 0,5mm
404.586



INKS BY CARAN D'ACHE

CARAN D'ACHE : ALL THE COLOURS OF THE EARTH

Drawing from the palette of colours to express a range of emotions is a simple gesture that has become a ritual. The ink bottle inspires the pen that draws the ink to the source of imagination...

Caran d'Ache, Maison de Haute Ecriture, offers all handwriting lovers a collection of inks with original, refined tints and hues - the Colours of the Earth.



INK BOTTLES

- 8010.009 Carbon Ink
- 8010.149 Blue Night Ink
- 8010.140 Blue Sky Ink
- 8010.052 Saffron Ink
- 8010.191 Caribbean Ink

- 8010.099 Storm Ink
- 8010.049 Grand Canyon Ink
- 8010.210 Amazon Ink
- 8010.080 Sunset Ink

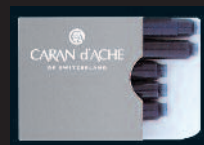

CARTRIDGES (5 PIECES)

- 8022.140 Blue
- 8028.009 Black

BALLPOINT PEN CARTRIDGES

GOLIATH:
AN INTERNATIONAL
BENCHMARK.
MADE IN SWITZERLAND



With its steel point containing a free-turning ball in tungsten carbide that provides a clean blot-free line, the legendary Goliath giant cartridge delivers up to 600 A4 pages of handwriting.

- Giant cartridges, steel point
- Large 8422.260 Blue
- 8428.109 Black
- Medium 8422.000 Blue
- 8428.000 Black
- 8420.000 Red
- 8418.000 Green
- Fine 8422.160 Blue
- 8428.009 Black
- 8420.070 Red

ECRIDOR
XS



- Ecriдор XS cartridges,
- 6522.100 Blue
- 6528.100 Black

ROLLERBALL PEN CARTRIDGES

ROLLER



- Rollercall pen cartridges, fine point
- 8222.160 Blue
- 8228.009 Black
- Rollercall pen cartridges, fine point for Ecriдор XS
- 6228.009 Black

FIBRES



- Fibres cartridges, medium point
- 8122.000 Blue
- 8128.000 Black
- fine point
- 8122.160 Blue
- 8128.009 Black

ROLLERBALL FLUID



- Cartridges rollerball fluid Varius
- medium point
- 8252.000 Blue
- 8258.000 Black

ERASERS



- Replacement erasers
- 505.000 Madison, Ecriдор; Hexagonal
- 506.000 Léman
- 507.000 Varius, Ecriдор XS

LEADS

GRAPHITE LEADS 0,5MM



- 6705.350 60mm HB
- 6705.351 60mm B

GRAPHITE LEADS 0,7MM

- 6707.350 60mm HB
- 6707.351 60mm B

COLOUR LEADS 2MM



- Blue, green, red, yellow
- 6077.786

All the collections are not available in all the countries.









**THE CARAN D'ACHE FOUNTAIN PEN:
THE IDEAL INSTRUMENT FOR HANDWRITING**

"The pen is the interpreter of the soul: what one thinks, the other expresses."
(Miguel de Cervantes)

Each Caran d'Ache writing instrument combines high technology with the matchless expertise of the craftsman. The nib and the ink feed both receive special attention and their secrets are carefully guarded.

From the machining of the ink-feed channel to the curvature and polishing of the pen, Swiss precision gives these writing instruments the genuine stamp of quality.

To offer personalized writing style and comfort, the nib of a fountain pen in the Varius collection is available in six point sizes, and in three sizes in the other collections.

-  EF extra-fine
-  F fine
-  M medium
-  B broad
-  OM oblique medium
-  OB oblique broad

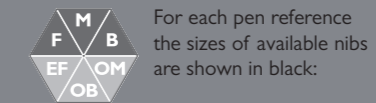

The fountain pens are supplied with a piston pump and two blue Caran d'Ache cartridges: the roller balls with a fine black cartridge, the ballpoint pens with a black Goliath giant cartridge, and the mechanical pencils with leads of 0.7mm diameter (except Ecridor XS: 0.5mm and Ecridor Artiste: 2mm).

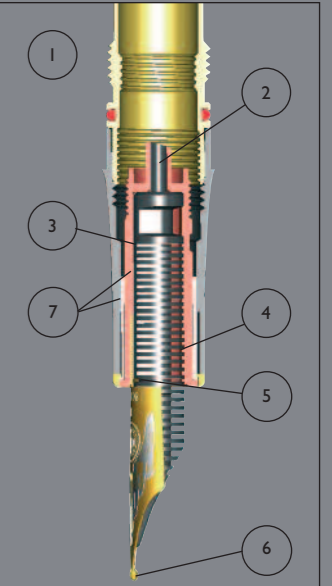

- 1. Front parts of a fountain pen
 - 2. Inkfeeder, an essential component for the ink flow
 - 3. Capillary ink-feed canal
 - 4. Ribs to compensate for changes in temperature and altitude
 - 5. Air-ink exchanger system
 - 6. Pen with welded and polished iridium ball
 - 7. The house and the body of the nib
- All parts of a Caran d'Ache writing block are assembled manually.

Each Caran d'Ache pen block must pass leakage, writing, and fast-writing tests. The nibs are then adjusted and ground by hand.

www.carandache.com

Caran d'Ache pens from www.penbox.co.uk sales@penbox.co.uk Tel: 01427 874433